

**Models:**  
**TS345**  
**Square Termination Cap**



This chimney termination cap has been tested for use with specific Hearth & Home Technologies Inc. fireplaces. Check with your local building code agency before you begin installation to ensure compliance with local codes, including the need for permits and follow-up inspections. If you encounter any problems regarding code approvals, or if you need clarification of any of the instructions contained here, contact your Hearth & Home Technologies Inc. dealer. For the dealer nearest you, please visit [www.hearthnhome.com](http://www.hearthnhome.com)

**Note:** An arrow (➔) found in the text signifies change in content.

**CAUTION**



**Sharp Edges**

- Wear protective gloves and safety glasses during installation.



**WARNING**



**Fire Risk**

- Intended for use with a metal chase top.
- Use of combustible materials will cause a fire hazard.

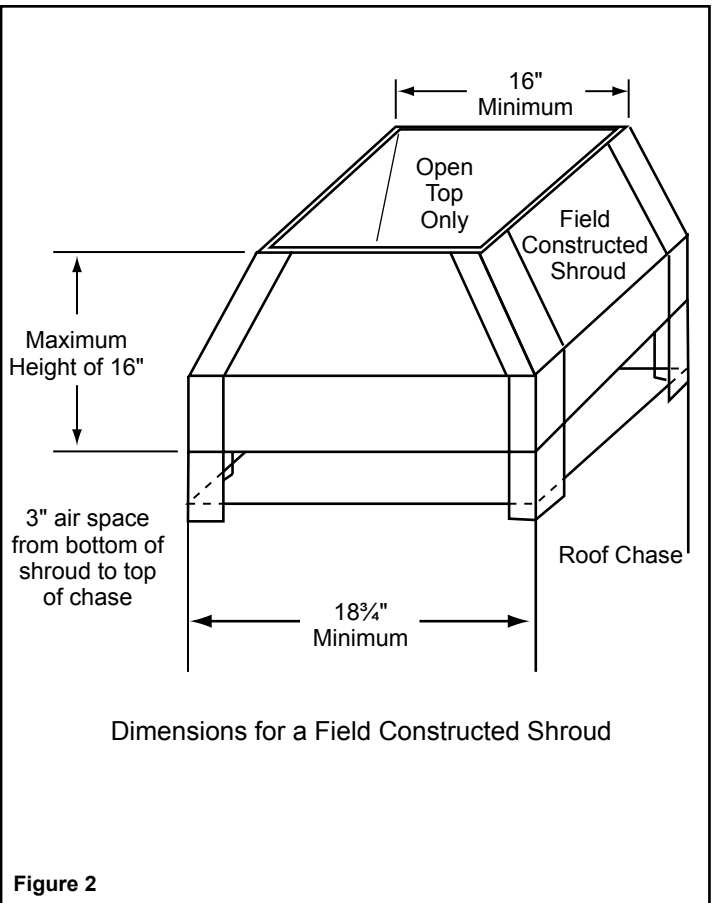
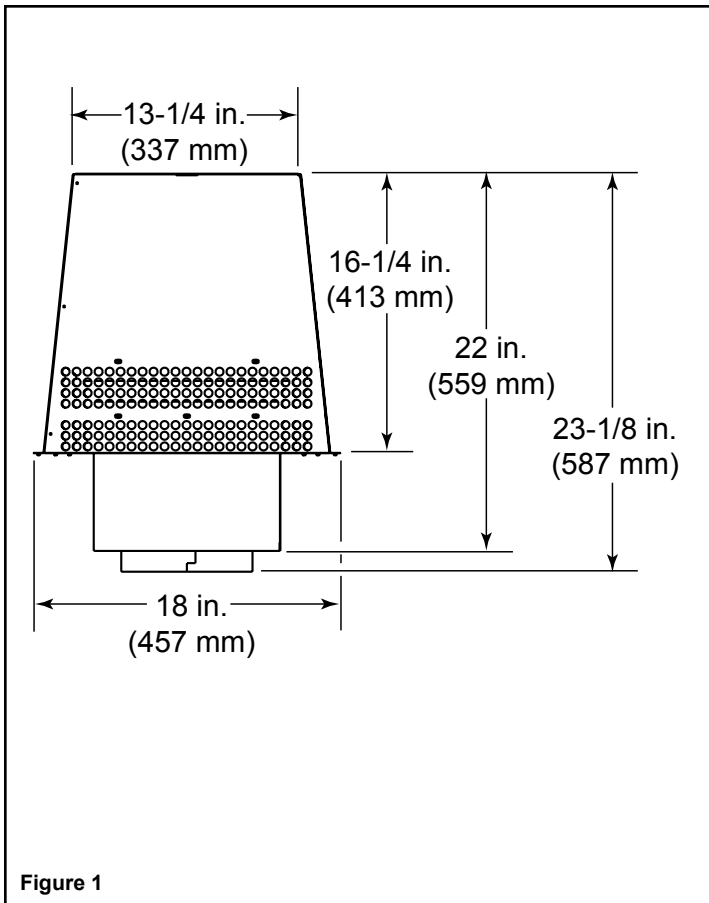

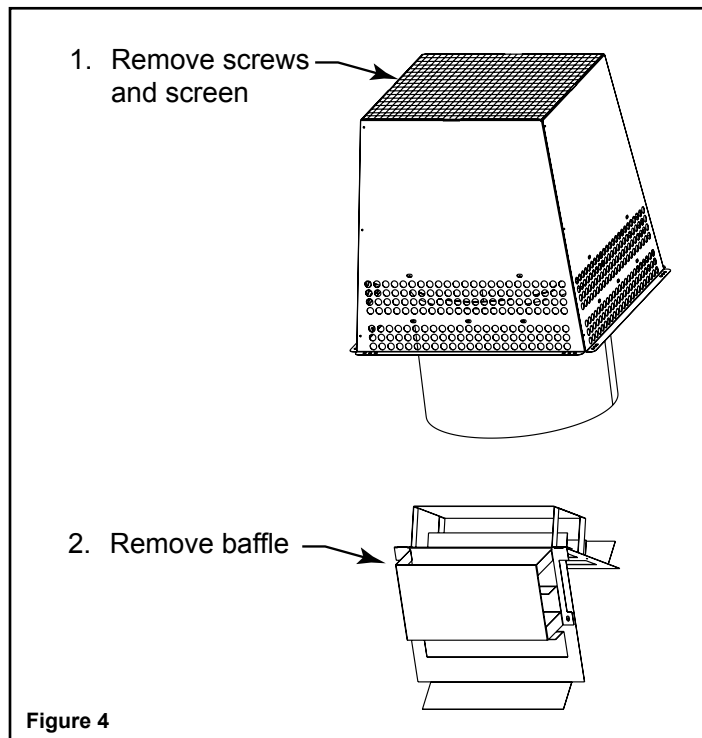
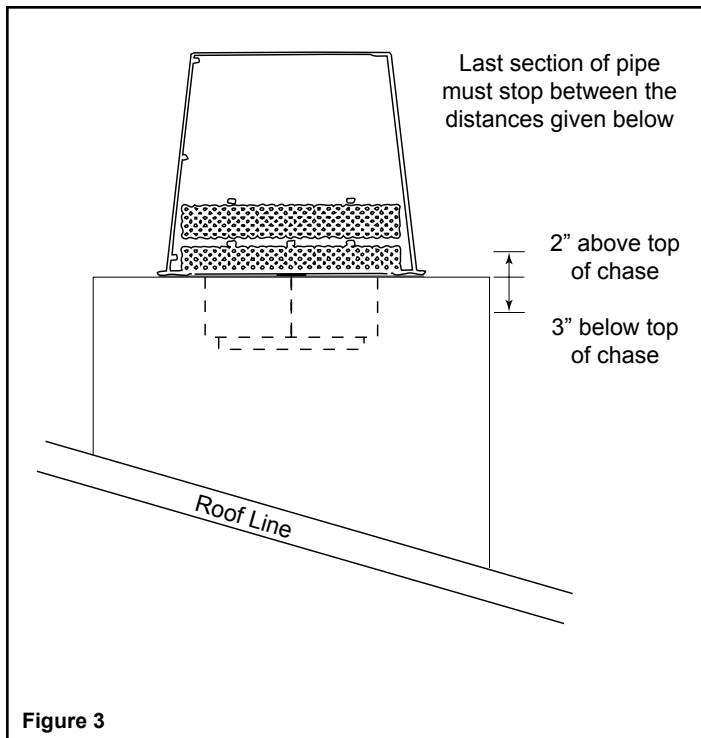

## Installation

- Install the chase top.
- Place the inner slip section into the inner section of the uppermost chimney section. Slip the outer slip section over the outer section of the uppermost chimney section. Press the termination assembly down until the flanges contact the chase top.

**Note:** The last chimney section must be located within 2" above or 3" below the chase top. See Figure 3.

- ➔ • Using the holes in the flanges as guides, drill 1/8" diameter holes in the chase top. Lift the cap, place waterproof sealant on the bottom of the flanges, push the flange onto the chase top and secure with the four screws provided in the fastener package. Place a small dab of waterproof sealant over each screw head to ensure a leak tight top.
- When a field constructed decorative surround is installed around this termination assembly, the shroud must meet or exceed the minimum dimensions shown in Figure 2. The chase must measure a minimum of 18 $\frac{3}{4}$ " x 18 $\frac{3}{4}$ ".
- For chimney cleaning, remove the four screws and the screen from the top of the cap. Lift out the baffle system. Clean baffle, screen and chimney, and reinstall everything. See Figure 4.

**Note:** To protect the cap against the effects of corrosion, we recommend that the termination caps be painted with rust resistant paint.